

PuREPower

5.0

USER MANUAL

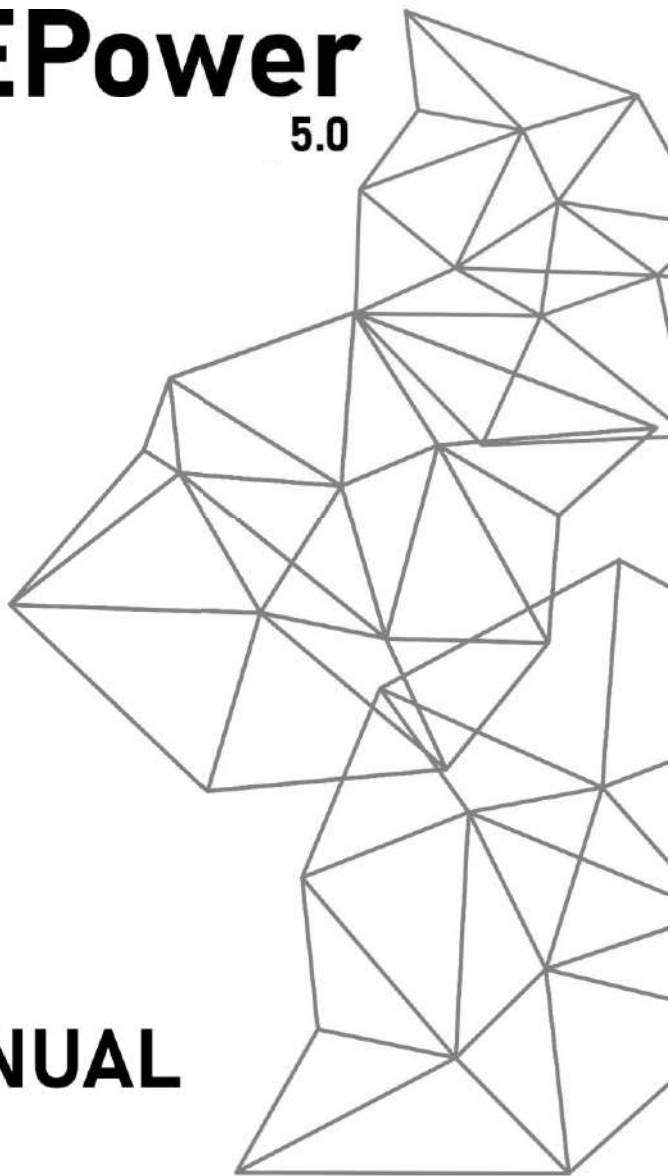

Table Of Contents

1. About This Manual	1
1.1 Purpose.....	1
1.2 Scope.....	1
2. Safety Instructions	1
3. Introduction.....	2
3.1 Features.	2
3.2 Basic System Architecture.	2
3.3 Product Overview	3
3.3.1 LCD Screen.	3
3.3.2 Bottom Panel & Side Panel.	3
4. Installation	4
4.1 Unpacking And Inspection	4
4.2 Preparation	4
4.3 Installing the device.....	4
4.4 AC Input/Output Connection.....	6
4.5 Suggested cable requirement for AC wires.....	6
4.6 PV Connection.....	7
4.7 PV Module Selection Guidelines.....	7
4.7.1 PV Module Wire Connection.....	8
4.7.2 PV Module MC4 connectors.	9
4.8 PV Module Specifications.	9
4.9 PuREPower Connecting line diagram.....	10
5. Operation.....	11
5.1 Power ON/OFF... ..	11
5.2 Operation and Display Panel... ..	12
5.3 LED indicators.	12
5.4 Function Keys.	12
6. Wi-Fi Connectivity Procedure	13
6.1 PURE BMS App Download Procedure	13
6.2 PURE BMS App Operation.	14
6.3 Wi-Fi Connectivity Procedure.....	15
6.4 PuREPower SoH Monitor Using Wi-Fi.....	17

- 7. Solar of Things Wi-Fi Connectivity..... 18**
- 7.1 Wi-Fi Solar Of Things App Connectivity Procedure... .. 18
- 7.1.1 APP Download..... 18
- 7.1.2 Registered Account..... 18
- 7.1.3 Supporting Network And Adding Device. 19
- 7.1.3.1 Wi-Fi Collector Connection Router..... 19
- 7.1.3.2 Add Device 19
- 7.1.4 Collector Fault Diagnosis and Indicator Light Judgment 21
- 7.1.4.1 Collector Fault Diagnosis 21
- 7.1.4.2 Collector Indicator Status 21
- 8. LCD Display Icons 22**
- 8.1 Function and alarm description 23
- 8.1.1 Fault Reference Code..... 23
- 8.1.2 Warning Indicator..... 24
- 8.2 Fault Code Display..... 24
- 8.3 Dry Contact Signal 25
- 8.4 Troubleshooting Guide 26
- 9. WHAT TO DO IN CASE OF AN EMERGENCY..... 27**
- 10. Warranty Policy 28**
- 11. Do's and Don'ts 29**
- 12. Instructions For Servicing 29**
- 13. Disposal and Recycling Information 30**
- 13.1 Environmentally Safe Disposal Practices..... 30
- 13.2 Battery Disposal and Recycling 30
- 14. Legal Disclaimers 30**
- 14.1 Limitation of Liability..... 30
- 14.2. Misuse Disclaimer 31
- 14.3. Third-Party Component Exclusions..... 31
- 14.4. Governing Law and Jurisdiction 31
- 15. PuREPower WARRANTY REGISTRATION CARD 32**
- 16. QR codes for PuREPower Installation Guidelines 32**
- 17. Display Settings & Operating Mode Descriptions..... 33**

1 About This Manual

1.1 Purpose

This manual describes the installation, operation, and troubleshooting of this unit (PuREPower). Please read this manual carefully before installation and operation. Keep the manual for future reference.

1.2 Scope

This manual provides safety and installation guidelines as well as information on tools and wiring.

2 Safety Instructions

WARNING: This chapter contains important safety and operating instructions. Read and keep this manual for future reference.

1. Before using the PuREPower, carefully read all instructions and cautionary markings provided throughout this manual.

2. Do not attempt to disassemble the unit. If service or repair is needed, contact a qualified service center. Incorrect reassembly may result in an electric shock or fire.

3. To minimize the risk of electric shock, disconnect all wiring before performing any maintenance or cleaning. Simply turning off the unit does not eliminate this risk.

4. CAUTION - The PuREPower UNIT must be installed only by qualified electrical personnel.

5. NEVER charge a frozen PuREPower.

6. For best performance, ensure that cable sizing follows the specified requirements mentioned in this manual. Proper cable selection is critical for the safe and efficient operation of the PuREPower unit.

7. Caution - Use extreme care when working with metal tools around the PuREPower unit. Dropping a metal object could result in a short circuit, sparking, or battery damage, potentially leading to fire or explosion.

8. AC Disconnection - Always follow the prescribed installation procedure when disconnecting the AC power. Refer to the INSTALLATION section of this manual for detailed instructions.

9. Grounding Instructions - This PuREPower unit must be connected to a permanent grounding system. Ensure compliance with all applicable local electrical codes and regulations during installation.

10. Warning - Servicing of this device should be performed only by qualified service personnel. If issues persist after consulting the troubleshooting guide, return the PuREPower unit to the authorized dealer or service center for further assistance.

11. NEVER cause AC output and DC input short circuited. Do NOT connect to the mains when DC input short circuits.

12. Stabilizer must be installed if each of phase voltage is not with in the range of 210 V to 250 V

3. Introduction

This multi-functional All in One PuREPower unit integrates an inverter, charger, and battery into a compact, wall-mounted design, providing uninterrupted power support. It features a comprehensive touch LCD color screen with user-friendly buttons, allowing easy configuration of settings such as battery charging current, AC/solar charging priority, and acceptable input voltage tailored to various applications.

3.1 Features

- Round Trip Efficiency - 97.0%
- Pure Sine Wave
- Dry contacts for load control
- Predictive & Cloud AI
- Safe & Secure
- 10+ Years Life
- Grid-Tied Enabled
- Single Phase to 3 Phase convertibility
- Smart & Connected (App, Wi-Fi and Bluetooth)
- Nano PCM for Thermal
- Time of Use
- Scalable
- Automatic Transfer Switch (ATS)
- Synchronize @ Solar, DG & Grid

3.2 Basic System Architecture

The following illustration shows the various power input sources (Grid/Generator , PV Modules) through which PuREPower draws, stores power and provides energy backup. It also showcases the various applications that can be powered using PuREPower.

PuREPower is capable of powering a wide range of apartment/home and motor related appliances like Elevators, Mixer Grinders, Ovens, Refrigerators, Air Conditioners , lighting fixtures etc. Also high power appliances like drill machine, grinding machines etc.,

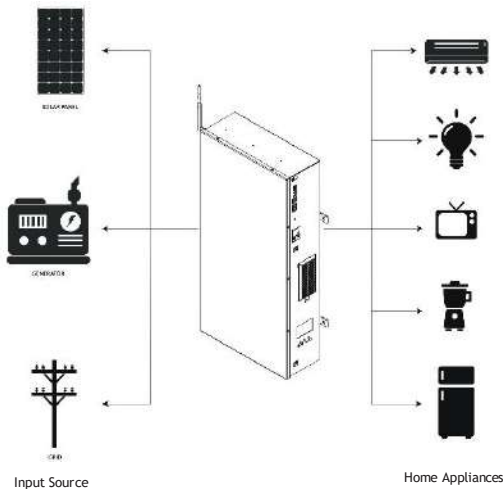

Hybrid System

3.3 Product Overview

3.3.1 LCD Screen

1. LCD display
2. Status indicator
3. Charging indicator
4. Fault indicator
5. ESC
6. UP
7. DOWN
8. ENTER

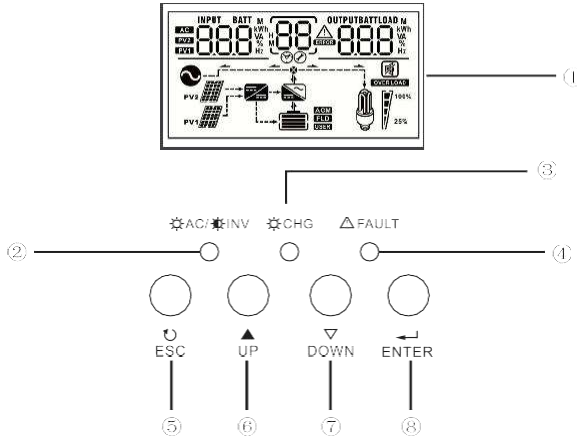

3.3.2 Bottom Panel & Side Panel

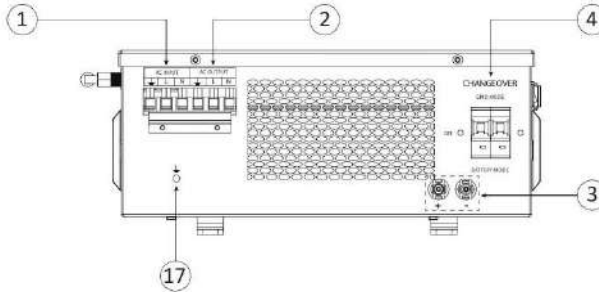

Bottom Panel

- | | |
|---|--|
| <ol style="list-style-type: none"> 1. AC Input 2. AC Output 3. Solar Panel Input 4. Changeover Switch 5. Power ON/OFF Switch 6. Display 7. Battery ON/OFF Switch 8. Battery MCB 9. Battery level indicator | <ol style="list-style-type: none"> 10. BMS Communication port 11. Parallel Communication Port 12. Restart Button 13. Dry Contactor 14. BMS/RS485 Communication Port 15. Wi-Fi Device Antenna Port 16. Restart 17. Output Earth/Ground Wire 18. Intake Air Filtration Grill (At both Side) |
|---|--|

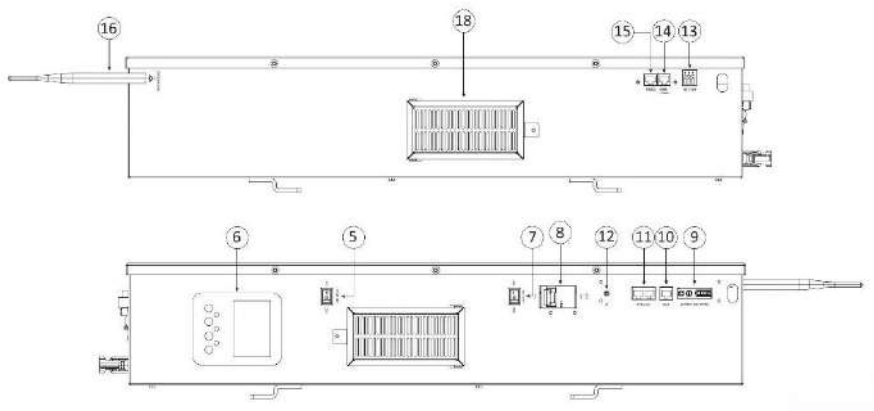

Side Panels

4 INSTALLATION

4.1 Unpacking and Inspection

Before installation, carefully inspect the PuREPower unit to ensure that no damage has occurred during shipping. Confirm that the package includes the following items :

- The PuREPower unit x 1
- Warranty Manual x 1
- Mounting bracket & Screws x 1
- Wi-Fi antenna booster x 1

4.2 Preparation

Before selecting the installation location, ensure proper ventilation is considered. The PuREPower unit is designed with built-in ventilation, and the fan surface is positioned near the exhaust outlet.

4.3 Installing the device

Please consider the following points before choosing the installation location:

- Do not install PuREPower on or near flammable construction materials
- To ensure adequate heat dissipation, maintain a clearance of approximately 20 cm on each side and 50 cm above and below the unit
- The recommended ambient temperature range for optimal operation is -20°C to 50°C. Note that performance may decline at temperatures above 40°C
- Ensure that surrounding objects and surfaces are positioned as illustrated in the

installation diagram to support proper ventilation and allow sufficient space for cable routing and maintenance.

- PuREPower should be installed in a manner that makes the display visible. This will help in any troubleshooting during an untoward service disruption.
- PuREPower should be installed on solid walls only; hollow brick structures/ gypsum board structures are not compliant. Any installation on structures that do not have load bearing capacity will result in external and internal damages that will affect the product functioning. This will also lead to void in warranty terms.
- The picture below shows the reference diagram:

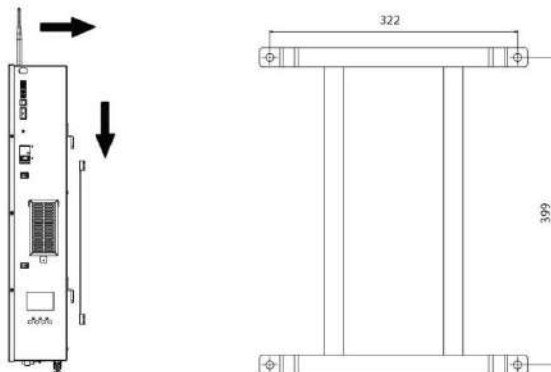
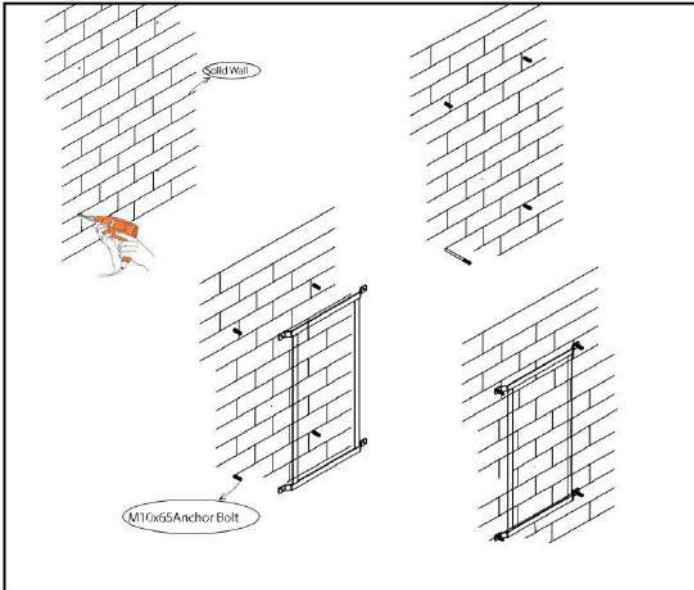

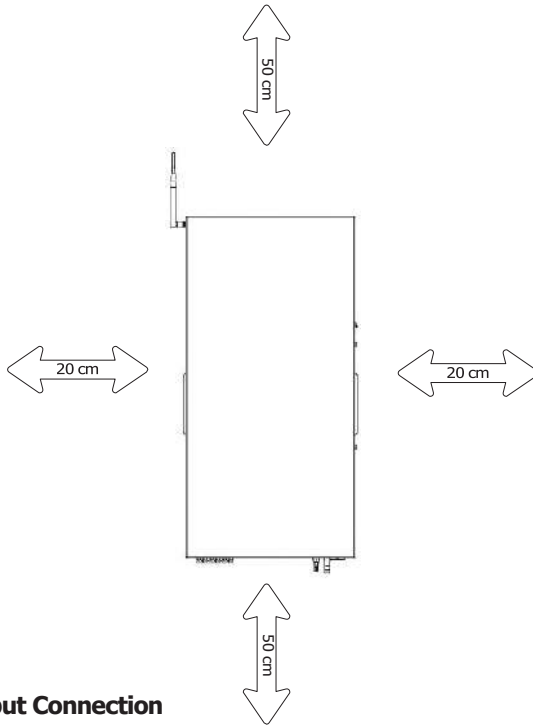

4.4 AC Input Output Connection

CAUTION ! Before connecting the PuREPower to the AC input power source, a dedicated AC circuit breaker must be installed between the PuREPower and the AC source. This is essential to safely disconnect the PuREPower during maintenance and to provide protection against overcurrent from the AC input. The recommended breaker specifications are provided in the table below.

PuREPower	AC MCB Rating	Power Line	AC Voltage
5.0	2P,25A	Single Phase	230V

Note: There are two terminal blocks labeled "INPUT" and "OUTPUT." Reversing these connections may cause damage to the PuREPower unit, which will not be covered under warranty. All wiring must be performed by a qualified electrician.

4.5 Suggested Cable Specifications for AC Wiring

PuREPower	Gauge	Torque Value
5.0	1C X 4 Sq mm X Cu	1.2-1.6Nm

NOTE : Load segregation is mandatory to ensure that the product is not over-loaded including the safety factor and the power-factor.After switching on the complete load, Confirm the performanceof PuREPower and record the load values,in both grid and off grid condition.If the total load exceeds 3.75kVA for PuREPower 5.0

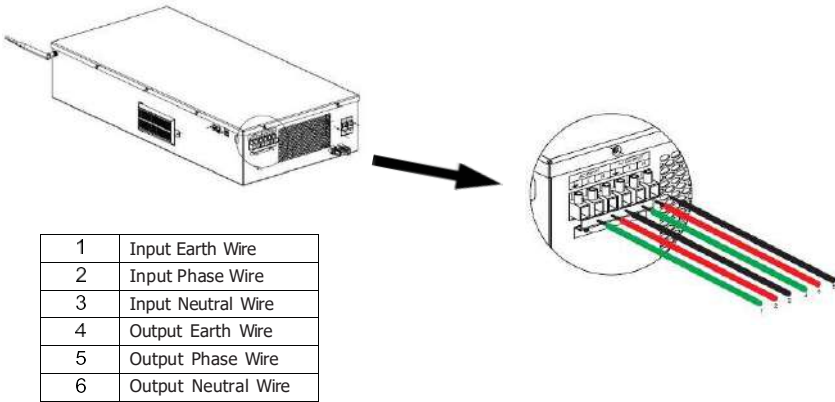

WARNING: Ensure that the AC power source is fully disconnected before installing any hardware into the PuREPower unit.

4.6 PV Connection

Before connecting the PuREPower unit to PV modules, a DCDB must be installed between the PV modules and the PuREPower. This is essential for system safety and maintenance purposes.

- All wiring must be performed by qualified personnel only.
- To ensure safe and efficient system operation, it is crucial to use appropriately rated cables for PV module connections.
- Using the correct cable size minimizes the risk of overheating or electrical hazards. Please refer to the recommended cable specifications below for proper sizing.

4.7 PV Module Selection Guidelines

When selecting suitable PV modules for use with the PuREPower unit, please ensure the following requirements are met :

- The open circuit voltage (Voc) of the PV module(s) must not exceed the maximum allowable PV array open circuit voltage specified for the PuREPower.
- For optimal system performance, the total supply voltage of the PV module(s) should fall within the recommended PV input voltage range of the PuREPower.
- If a single PV module does not meet the voltage requirement, multiple PV modules must be connected in series to achieve the appropriate voltage level.

Failure to follow these guidelines may lead to reduced efficiency or potential system damage.

4.7.1 PV Module Wire Connection

Check the polarity of the wires from the PV modules and the PV input connectors. Connect the positive (+) wire to the positive (+) terminal of the PV input connector, and the negative (-) wire to the negative (-) terminal of the PV input connector.

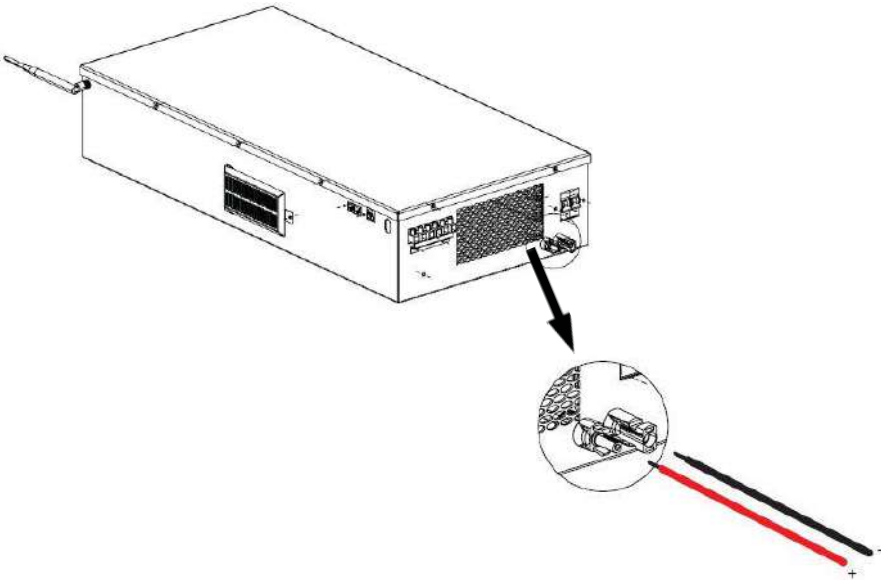
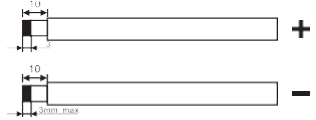

4.7.2 PV Module MC4 connectors



4.8 PV Module Specifications

Model	PuREPower 5.0
PV Charging Mode	MPPT
MAX.PV Input Power	8500W
MPPT Tracking Range	60 ~ 450VDC
Best Voltage	300~400V
MAX.PV Input Voltage	450 VDC
PV MAX input Current	27A
PV MAX Charging Current	100A
MAX AC Charging Current	60A
MAX Charging Current	100A

4.9 PuREPower Connecting Line Diagram

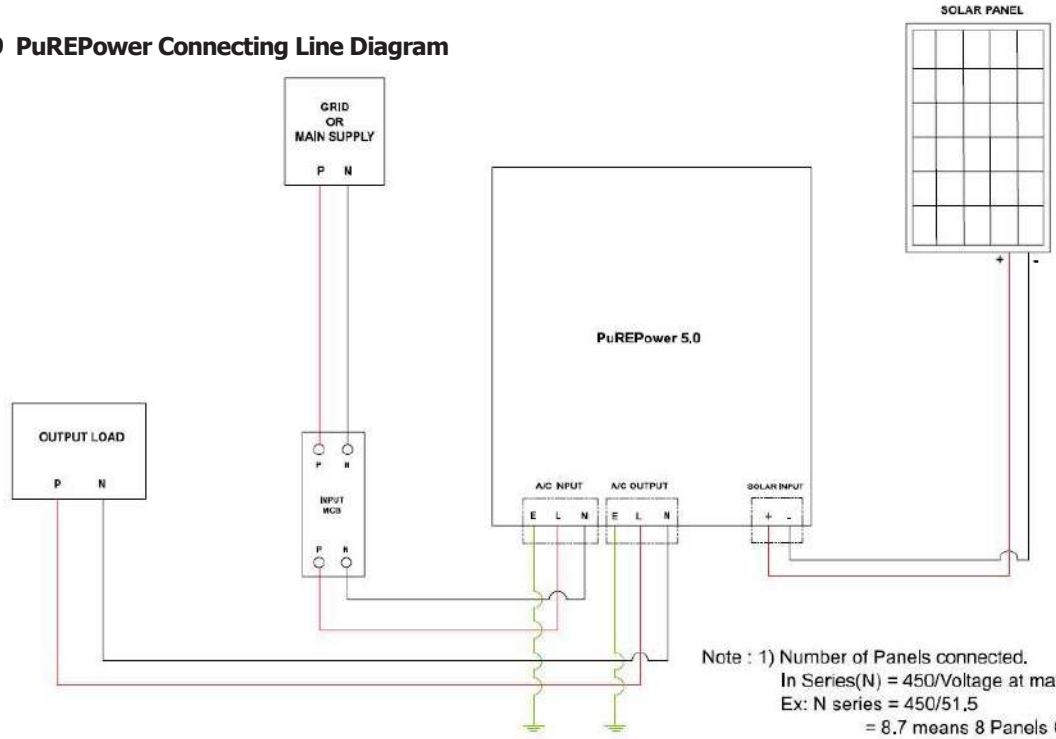

Note : 1) Number of Panels connected.
 In Series(N) = 450/Voltage at maximum power of one panel(VDC)
 Ex: N series = 450/51,5
 = 8.7 means 8 Panels Connected

Note: Don't shortcircuit input and output terminals

2) If a net meter is installed, the stabilizer should be connected to the PuREPower output side,

Single Phase SLD of PuRPower 5.0

Do NOT connect the PuREPower output line using plug-type connections (as shown in the image above).



5 OPERATION

5.1 Power ON/OFF

Once PuREPower is correctly installed

1. Switch on the PuREPower MCB located at the right side of the unit, as shown in the picture below.

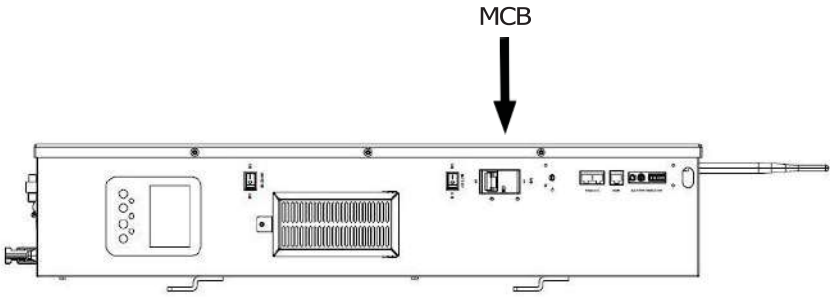

2. Then, press the ON switch located on the side of the case to power on the unit, as shown in the picture below.

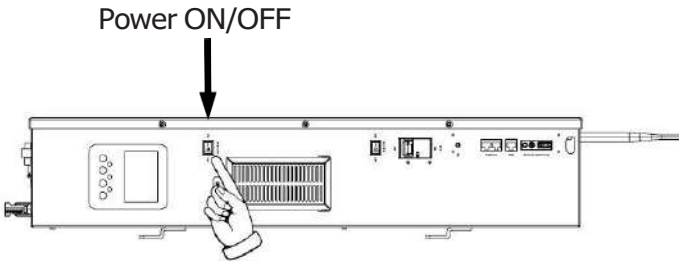

5.2 Operation and Display Panel

The operation and display panel, located on the side panel of PuREPower, is shown in the table below. It includes three indicators, four function keys, and an LCD display that provides details on the operating status, as well as input and output power information.

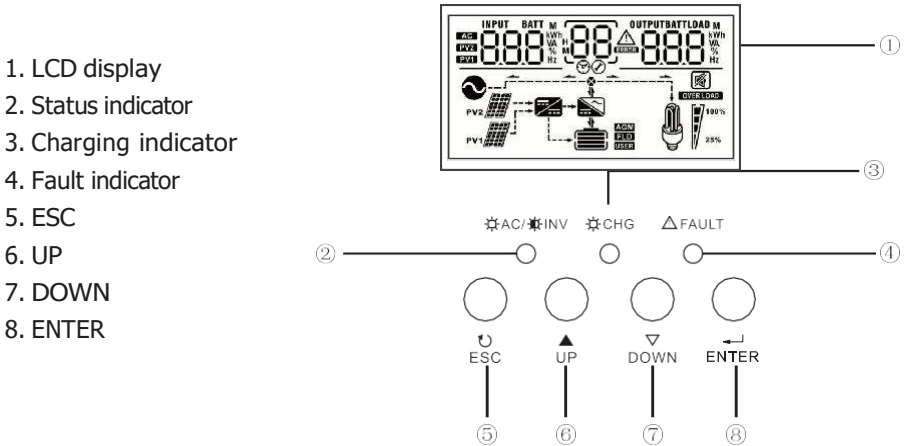

1. LCD display
2. Status indicator
3. Charging indicator
4. Fault indicator
5. ESC
6. UP
7. DOWN
8. ENTER

5.3 LED indicators

LED Indicator		Messages	
AC/INV	Green	Solid On	The output is powered by the utility in Line mode.
		Flashing	Output is powered by battery or PV in battery mode.
CHG	Orange	Solid On	The unit is fully charged.
		Flashing	The unit is charging.
FAULT	Red	Solid On	The fault occurs in the PuREPower.
		Flashing	A warning condition occurs in the PuREPower.

5.4 Function Keys

Function Keys	Description
ESC	To exit setting mode
UP	To go to the previous selection
DOWN	To go to the next selection
ENTER	To confirm the selection in setting mode or enter setting mode

6. Wi-Fi connectivity procedure :

6.1 PURE BMS App Download Procedure

Search and download PURE BMS App from Play Store (Android) or App Store (iOS).

Step 1:

- Ensure that Bluetooth and Wi-Fi are switched on in your mobile device.
- Make sure to have the Wi-Fi router password handy for later use.
- Verify that the Wi-Fi network is operating on a 2.4GHz frequency.



Step 2 :

- Open either the Play Store (Android) or App Store (iOS).
- Search for PURE BMS and install the app. Once installed, open the app.

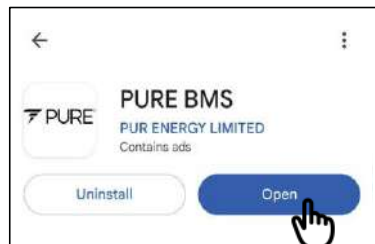
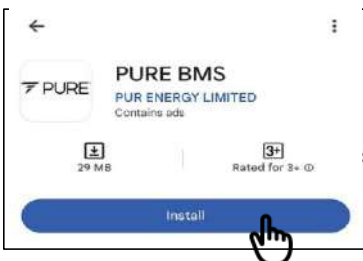
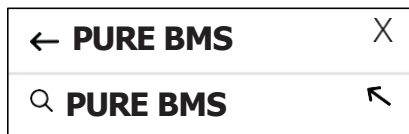

6.2 PURE BMS App Operation

Step 3 :

Click on Agree, then select "Remote Monitoring."

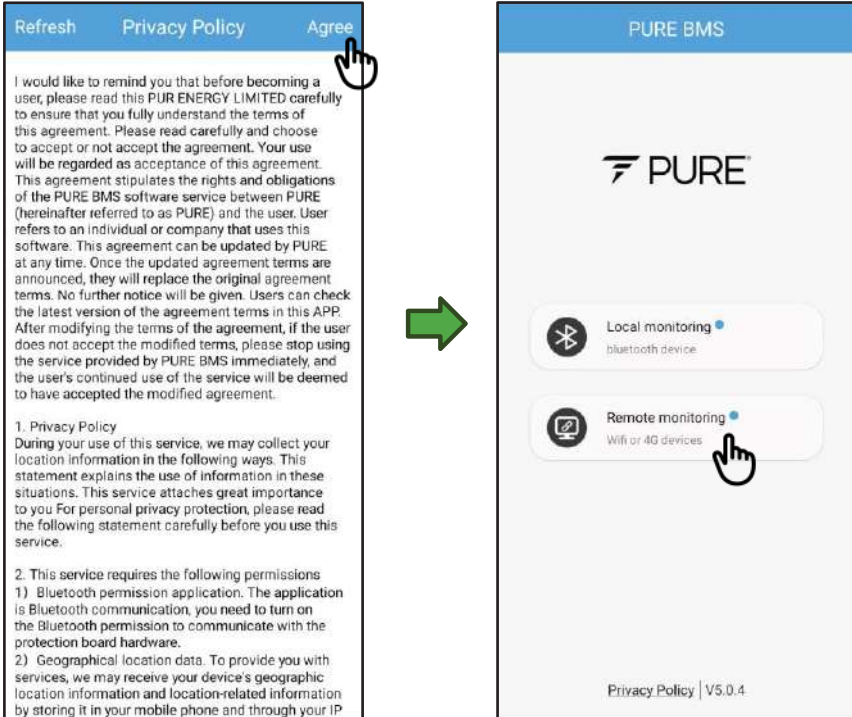

Step 4 :

- Enter the provided email and password, then click Login.(if you are a new login please click on immediate registration)
- Choose the "Parallel" mode. During this process, allow all pop-up access requests.

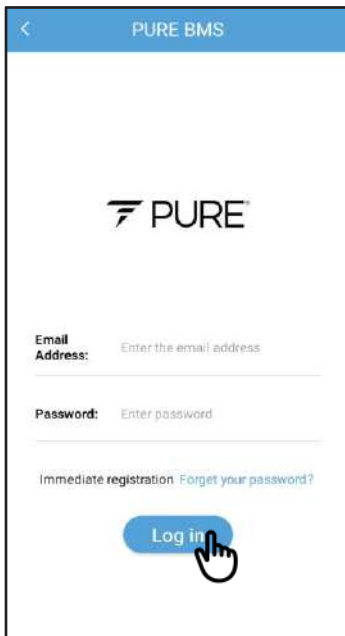

6.3 Wi-Fi Connectivity Procedure :

Step 5 :

- In the Smart BMS app, click on the "Connecting Devices +" icon in the upper-right corner and select "Wi-Fi Devices."

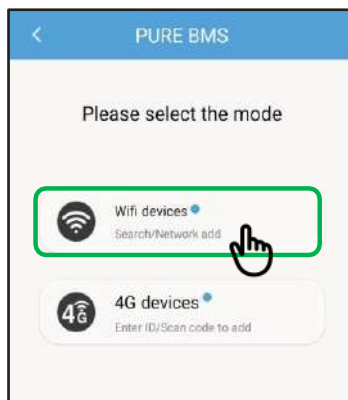

Step 6 :

- Select the desired Wi-Fi device name, then click Next Step.
- Enter your Wi-Fi router password and proceed to the next step.

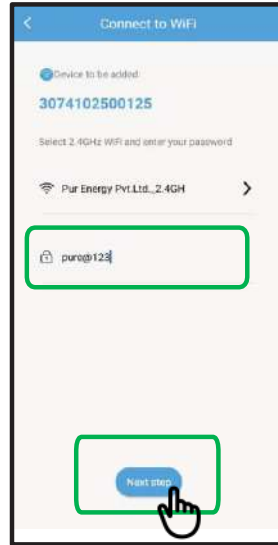

Step 7 :

- After successfully connecting to the device, you should see the “Binding Device” message. Click Save to complete the process.

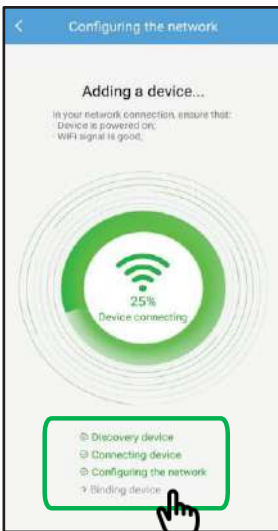

Step 8 :

- The network and device allocation process will now be complete. On the "Connect Device" page, the corresponding Wi-Fi module will appear. If the status shows "Online," you can select the PuREPower device and open it, as shown in the figures below.

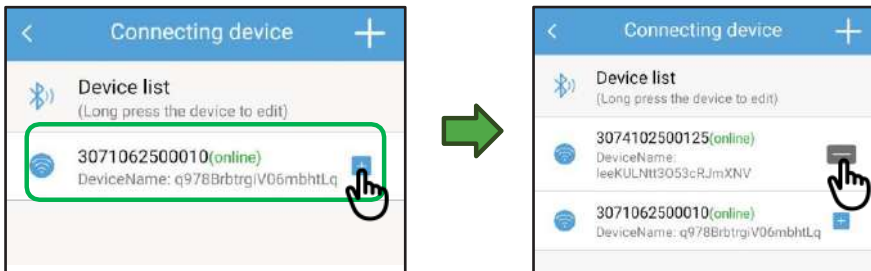

7.4 PuREPower SoH Monitor Using Wi-Fi

Now we can monitor PuREPower State of Health(SoH) like SoC%(State of Charge), Voltage, Current, No.Cycles, and Temperature etc.

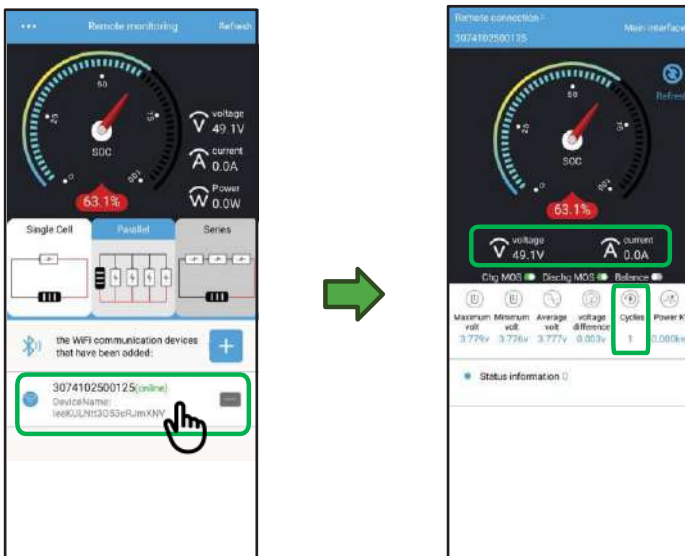

7. Solar of Things Wi-Fi Connectivity

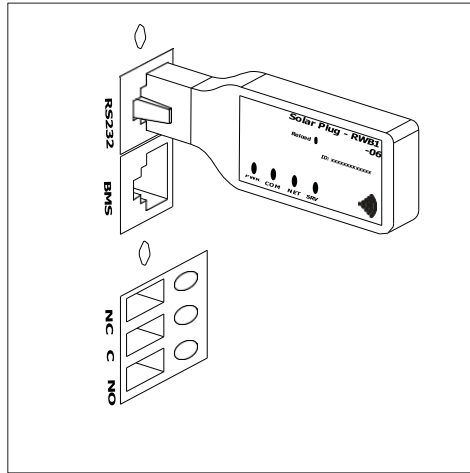

7.1 Wi-Fi Solar Of Things App Connectivity Procedure

- Wireless Wi-Fi Distribution Network

7.1.1 APP Download

Step 1 : Scan the QR, click on the link to download the app.

Step 2 : Or scan the QR code on the given Wi-Fi device.

Step 3 : Search in the Play Store to download the APP named "Solar of Things" for download.

7.1.2 Registered Account

- On the App home page, click the "Sign Up" button, fill in the relevant information according to the prompt, and complete the registration.

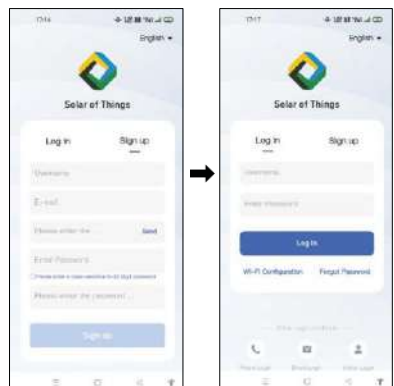

7.1.3 Supporting Network And Adding Device

7.1.3.1 Wi-Fi Collector Connection Router

- After the PWR(Power) light indicator on the device/collector is on, turn on the mobile phone Bluetooth and Solar of Things App, click the "Wi-Fi Configuration" button to enter the "Searching" page, and the page will automatically display the nearby Bluetooth device

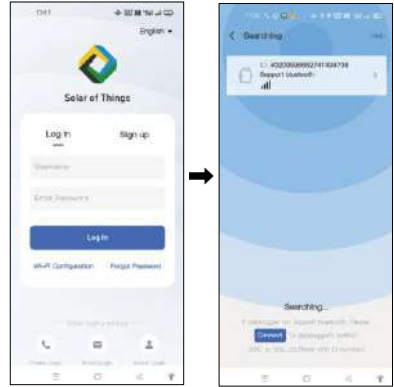

- Select the device/collector that needs to be distributed, enter the matching webpage, and click the search icon. You can choose the Wi-Fi hotspot name.

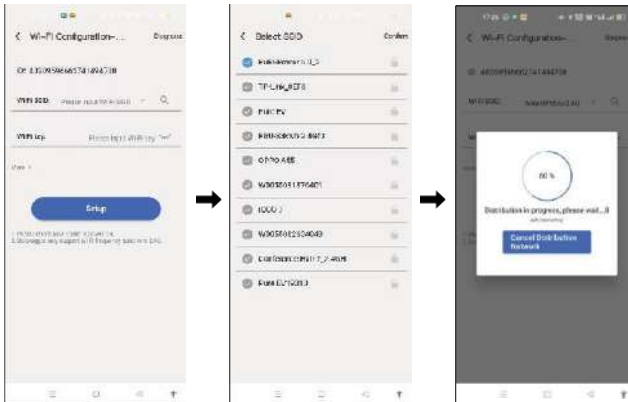

7.1.3.2 Add Device

Step 1:

- Enter the homepage of the APP, click "+" in the upper right corner, enter the device to add the page, close the mobile phone close to the device, and the app scan the device automatically

- After scanning to the device, select the ID that is consistent with the ID of the collector tag, and click "Add"

Note : Please confirm the collector ID before scanning. If the ID information as not found on the surface of the machine, you can view the ID on the matching

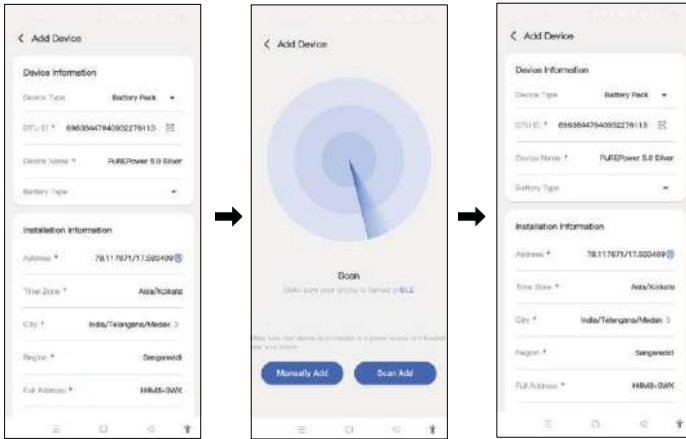

Step 2 : "Manually Add", complete the adding device according to the interface prompt, manual output collector ID, name, and other information

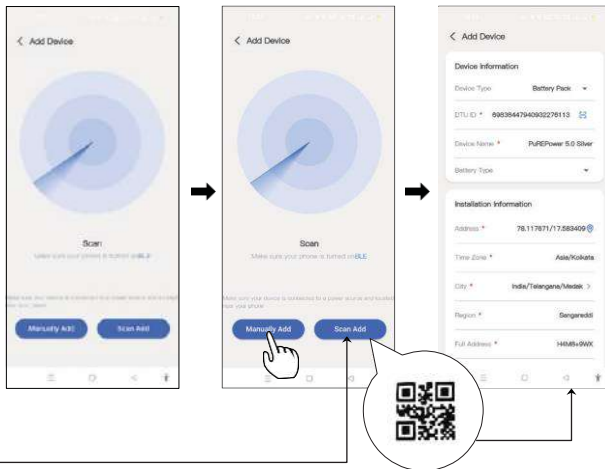

Step 3 : _____

"Scan Add", scan the QR code ID number of the collector film, and use the device with the corresponding collector

7.1.4 Collector Fault Diagnosis and Indicator Light Judgment

7.1.4.1 Collector Fault Diagnosis



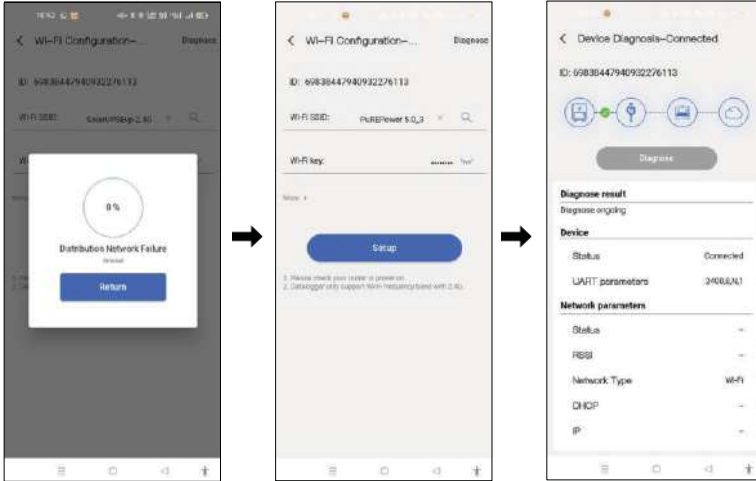













1) After the device distribution network is completed or fails, you can make a failure diagnosis by clicking on the upper right "Diagnose".







7.1.4.2 Collector Indicator Status

- PWR (power indicator light):
On: normal power supply
Off: abnormal power supply
- COM (serial port transmission indicator):
Off: Number of data interactions
Off for 0.3 seconds, on for 0.9 seconds : serial output data
Off for 0.3 seconds, on for 0.3 seconds : serial port receiving data
On: Two-way receiving and receiving
- Net (network status indicator):
Off for 0.3 seconds, on for 3 seconds : STA mode connects the upper router
Off for 0.3 seconds, on for 0.3 seconds : STA is not connected to the upper router
- SRV (server connection indicator)
On: Has been connected to the server
Off. Uninterrupted to the server

8. LCD Display Icons

















Icon	Function			
Input source information				
	Indicates the AC input			
	Indicates the 1 st PV panel input			
	Indicates the 2 nd PV panel input			
Left digital display information				
	Indicate input voltage, input frequency, battery voltage, V1 voltage, PV2 voltage, charger current			
The middle digital display information				
	Indicates the setting programs.			
	Indicates the warning and fault codes. Warning: Flashing BB with warning code Fault: display BB with fault code			
The right digital display information				
	Indicate the output voltage, output frequency, load percent, load VA, load W, PV1 charger power, PV2 charger power, DC discharging current.			
Battery information				
	Indicates battery level by 0-24%,25-49%,50-74% and 75-100% and charging status.			
	1 bar Indicates 25% charge, 2 bars indicate 50%, 3 bars indicate 75%, and 4 bars indicate a fully charged battery at 100%			
Load information				
	Indicates overload			
	Indicates the load level by 0-24%,25-50%,50-74%, and 75-100%.			
	0%-25%	25%~50%	50%-75%	75%~100%
				
Mode operation information				
	Indicates the unit connects to the mains.			

 PV1	Indicates the unit connects to the 1 st PV panel
	Indicates the solar charger is working
	Indicates the DC/AC PuREPower circuit is working.
Mode operation information	
	Indicates the unit alarm is disabled.

8.1 Function and alarm description











- **Fault : The PuREPower enters the fault mode, the red LED light is always on and the LCD displays the fault code.**

8.1.1 Fault Reference Code





Fault Code	Fault Event	Icon on
01	Fan is locked when PuREPower is off.	
02	Over -temperature or NTC is not connected well.	
03	Battery voltage is too high.	
04	Battery voltage is too low.	
05	Output short-circuits or over-temperature is detected by internal converter components.	
06	Output voltage is too high.	
07	Over load time out.	
08	Bus voltage is too high	
09	Bus soft start failed	
51	Overcurrent's or surges	
52	Bus voltage is too low	
53	PuREPower soft start failed	
55	Over DC voltage in AC output	
57	Current sensor failed	
58	Output voltage is too low	
59	PV voltage is over limitation	







Alarm: The red LED flashes, and the LCD displays an alarm code, the PuREPower does not enter the failure mode

8.1.2 Warning Indicator

Warning Code	Warning Event	Audible Alarm	Icon Flashing
01	Fan is locked when PuREPower is on	Beep three times every second	
02	Over temperature	None	
03	Battery is over-charged	Beep once every second	
04	Low battery	Beep once every second	
07	Overload	Beep once every 0.5 second	
10	Output power derating	Beep twice every 3 seconds	
15	PV energy is low.	Beep twice every 3 seconds	
16	High AC input (>280VAC) during BUS soft start	None	
E9	Battery equalization	None	
6P	Battery is not connected	None	

8.2 Fault Code Display

Fault Code	Fault Event	Icon On
60	Power feedback protection	
61	Communication lost	
71	Firmware version inconsistent	
72	Current sharing fault	
80	CAN fault	

Fault Code	Fault Event	Icon On
81	Host loss	
82	Synchronization loss	
83	Battery voltage detected different	
84	AC input voltage and frequency are detected differently	
85	AC input voltage and frequency are detected differently	
86	AC output mode setting is different	

8.3 Dry Contact Signal

There is one dry contact (3A/250VAC) available on the rear panel. It could be used to deliver signal to external device when battery voltage reaches warning level.



1. Confirm hardware prerequisites

The generator must support remote control: It should have a "two-wire start" or dry contact control function (typically a Remote Start interface). If the generator only has key start or automatic transfer switch (ATS) mode, it cannot be connected directly.

Prepare the cable: Use a pair of 0.5 mm² - 1.5 mm² double-core shielded cables for signal transmission.

2. Identify the IP21 PuREPower NO NC ports

Unit Status	Condition	Dry Contact Port:NC& C	Dry Contact Port: NC & C
Power OFF	Unit is OFF and no output is powered	Close	Open
	Normal mode Battery voltage < Low DC warning voltage	Open	Close

Power ON	Output is powered from battery or solar	Battery voltage > Float charging voltage	Close	Open
		Solar first mode Battery voltage < Solar to AC voltage	Open	Close
		Battery voltage > AC to DC voltage	Close	Open

On the control panel or bottom of the IP21 PuREPower, locate the communication terminal (COM). Identify two specific pins:

Pin 7 (or labeled DO+/RELAY): Positive terminal of the dry node output signal.

Pin 8 (or labeled DO-/COM): Common output signal terminal for dry nodes.

3. Connect the generator port

On the control panel of the diesel generator, locate the terminal block for the Remote Start Switch (remote start interface).

Connect Pin 7 of the IP21 PuREPower to the generator's Start terminal.

Connect Pin 8 of the IP21 PuREPower to the generator's Common terminal.

Common error: Do not connect dry nodes to the generator's emergency stop terminals; otherwise, errors will persist.

8.4 Troubleshooting Guide

This section provides guidance on identifying and resolving common issues encountered with the unit. Refer to the problem, symptoms, possible causes, and recommended corrective actions below

Problem	LCD/LED/Buzzer	Explanation/Possible Cause	What To Do
Unit shuts down automatically during startup process	LCD/LEDs and buzzer will be active for 3 seconds and then complete off.	The battery voltage is too low	1. Re-charge battery. 2. Replace battery.
No response after power on.	No indication	1. The battery voltage is far too low 2. Internal fuse tripped	1. Contact repair center for replacing the fuse. 2. Re-charge battery. 3. Replace battery.
Mains exist but the unit works in battery mode.	Input voltage is displayed as 0 on the LCD and green LED is flashing.	Input protector is tripped	Check if AC breaker is tripped and AC wiring is connected well.
	Green LED is flashing	Insufficient quality of AC power. (utility or Generator)	1. Check if AC wires are too thin and/or too long. 2. Check if generator (if applied) is working well or if input voltage range setting is correct. (UP-->Appliance).
When the unit is turned on, internal relay is switched on and off repeatedly.	LCD display and LEDs are flashing	Battery is disconnected.	Check if battery wires are connected well.
Buzzer beeps continuously and red LED is on.	Fault code 07	Overload error. The PuREPower is overloaded 105% and time is up.If PV input voltage is higher than specification, the output power will be derated.	Reduce the connected load by switching off some equipment. Reduce the number of PV modules in series or the connected load.

Buzzer beeps continuously and red LED is on.	Fault code 05	Output short circuited	Check if wiring is connected well and remove abnormal load.
	Fault code 02	Temperature internal converter component is over 120°C.	Check whether the airflow of the unit is blocked or whether the ambient temperature is too high.
	Fault code 03	Battery is over-charged. The battery voltage is too high.	Return to repair center. Check if spec and quantity of batteries meet requirements
	Fault code 01	Fan fault	Replace the fan.
	Fault code 06/58	Output abnormal (PuREPower voltage below 190Vac or higher than 260Vac)	1. Reduce the connected load. 2. Return to repair center.
	Fault code 08/09/53/57	Internal components failed.	Return to repair center.
	Fault code 51	Over current or surge.	Restart the unit
	Fault code 52	Bus voltage is too low	Restart the unit; if the error happens again, please return to repair center.
	Fault code 58	Output voltage is unbalanced.	Return to repair center.
	Fault code 59	PV input voltage is beyond the specification	Reduce the number of PV modules in series.

9. WHAT TO DO IN CASE OF AN EMERGENCY

If PuREPower is making unusual noises:

- Turn off all PuREPower, then turn off the AC breaker to PuREPower.
- Turn off the PuREPower integrated DC MCB.
- Ensure that nothing is blocking the air intake or in the fan.

In all cases, once the situation is stable, contact the Certified Installer who installed the system.

10. Warranty Policy :

PuREPower provides a warranty of 60 months for the battery and 36 months for both the inverter and protection board (BMS), beginning from the date of purchase. The warranty that the battery will retain at least 70% of its capacity for the duration of the warranty period. All other components are covered for one year warranty

S.No	Item	Base Warranty
1	Battery Pack	5 Years
2	BMS	3 Years
3	Integrated Mother-board	3 Years
4	All Electrical Items & Consumables	1 Years
5	Cloud AI Support	5 Years
6	Firmware Upgrades	3 Years
7	Remote Data Monitoring	3 Years
8	Cloud Alerts	3 Years
9	Deep Discharge Coverage	Applicable only if 24x7 Wi-Fi Available and Limited to 5 Years

The repair or replacement of the PuREPower is subject to the terms and conditions mentioned in the battery warranty policy.

The Warranty Stands Void in Case of the Following Cases :

- Warranty claims will not be accepted under any circumstances if the damage or defect arises from the following causes. These conditions fall outside the scope of PuR Energy Ltd warranty obligations.
- Damage caused by insufficient ventilation or restricted airflow, resulting in reduced cooling performance, is not covered under warranty.
- Warranty is void if the product is installed improperly or by an installer who is not accredited by PuR Energy Ltd.
- Any defects arising from incorrect or non-compliant use, installation, commissioning, start-up, or operation of the product are not eligible for warranty claims.
- Damage caused by improper wiring, including electrical arcing or harm to the product or its components, is excluded from warranty coverage.
- Mishandling or misuse of the product by the installer or end-user, such as dropping the product during installation, will void the warranty.

- Damage resulting from force majeure events—such as lightning strikes, overvoltage, storms, fire, or flooding—is not covered under this warranty.
- Any damage incurred during incorrect or careless transportation of the product is not covered by the warranty. Unauthorized repair, modification, or reinstallation of the product will void all warranty obligations
- Water ingress, corrosive gas damage, or installation in dirty environments, causing particles to affect performance — is not covered under this warranty.
- If PuREPower Unit is idle/ inoperative condition for more than 6 months can lead to void in warranty terms

11.Do's and Don'ts

Do's

- Ensure installation is performed by authorized personnel
- Verify proper grounding and secure electrical connections.
- Use the app or cloud platform to monitor performance and receive alerts regularly.
- Ensure the unit is placed in a well-ventilated, dry area and away from direct sunlight to prevent overheating.
- Report faults immediately and ensure repairs are performed by authorized technicians
- If you plan to leave for a long time (≥ 30 days), you should comply with the following requirement to ensure that the SOC system of the battery is above 60% and the power switch is kept OFF. Keep in mind that the system should restart to charge the battery within 90 days.

Don'ts :

- Do not connect loads exceeding the rated capacity of the system.
- Do not attempt to repair or modify the unit without consulting authorized service personnel.
- Do not expose the unit to water, direct sunlight, corrosive chemicals, or physical shocks.
- Do not ignore fault alerts or fail to address them promptly.
- Do not remove the Wi-Fi module or disable the cloud monitoring setup.

12 . Instructions For Servicing

When the PuREPower is not functioning or for any query follow below instructions:

- Connect to the installer/dealer for immediate assistance or call toll-free No:1800 212 6440
- Our service team will guide you whether PuREPower to be sent back for repair or can be serviced near your location.
- The on-site visit charges are applicable as per the standards. In case of any warranty component replacements, only components are covered under warranty.
- PuREPower installation charges are applicable.

Do not remove the Wi-Fi module or disable the cloud monitoring setup.

13.Disposal and Recycling Information

13.1 Environmentally Safe Disposal Practices

To minimize environmental impact and ensure the safe disposal of this PuREPower, users are advised not to dispose of the product with regular household waste. Instead, it should be handed over to an authorized electronic waste collection centre or returned to the manufacturer for proper recycling or disposal. Improper disposal may lead to environmental hazards or pose health risks.

This product is designed in compliance with applicable environmental standards and should be disposed of by local laws and regulations governing electronic waste.

13.2 Battery Disposal and Recycling

- If the PuREPower includes a built-in or external battery, please note:
- Batteries contain hazardous substances and must be disposed of carefully to avoid soil and water contamination.
- Do not incinerate, dismantle, or puncture the battery.
- Used batteries must be returned to the authorized collection centers or recyclers approved under the E-Waste (Management) Rules, 2022, as notified by the Ministry of Environment, Forest and Climate Change, Government of India.
- For lithium-ion batteries, users should consult local battery recycling programs or contact the manufacturer for take-back options.
- By disposing of this product and its components responsibly, you contribute to environmental conservation and support sustainable waste management practices

14.1 Limitation of Liability

- The manufacturer and its authorized distributors shall not be liable for any direct, indirect, incidental, consequential, or special damages arising out of the use or inability to use this product, even if advised of the possibility of such damages. This includes, but is not limited to, damages for loss of profits, data, business interruption, or personal injury.

The total liability of the manufacturer, whether in contract, tort, or otherwise, shall in no case exceed the purchase price of the product.

14.2. Misuse Disclaimer

This product is designed to be used strictly in accordance with the instructions provided in this manual. The manufacturer shall not be held responsible for any damage, injury, malfunction, or loss caused due to:

- Improper installation
- Unauthorized modification
- Operation under abnormal conditions (e.g., excessive load, extreme temperatures, or humidity)
- Use of incompatible or substandard accessories
- Failure to perform recommended maintenance

Any such use shall immediately void the warranty and the user shall bear all responsibility for resulting consequences.

14.3. Third-Party Component Exclusions

- This PuREPower may require integration with third-party components such as external batteries, solar panels, wiring, or circuit protection devices. The manufacturer disclaims all liability for performance issues, malfunctions, or damage resulting from the use of :
- Non-recommended or substandard third-party components
- Improper installation of such components
- Lack of compatibility or certification

The warranty shall not extend to any issues arising from the failure or malfunction of third-party accessories not supplied or recommended by the manufacturer

14.4. Governing Law and Jurisdiction

- This product and any disputes arising out of or in connection with its purchase, usage, warranty, or interpretation of this manual shall be governed by and construed in accordance with the laws of India.
- All disputes, claims, or proceedings arising out of this product shall be subject to the exclusive jurisdiction of the competent courts at Hyderabad, Telangana, and no other court shall have jurisdiction in such matters

15. PuREPower WARRANTY REGISTRATION CARD

CUSTOMER NAME: _____

ADDRESS 1: _____

_____ **CITY** _____

STATE _____ **PIN CODE** _____

MOBILE NO: +91 _____

MAIL ID: _____

PuREPower MODEL : _____ **PuREPower S.NO:** _____

SOLD ON: DD _____ **MM** _____ **YY** _____ **DEALER CODE:** _____

STAMP & SIGNATURE DEALER

CUSTOMER SIGNATURE

16. QR codes for PuREPower Installation Guidelines

**For Installation
Videos**



For Safety Protocol

After completing the installation of PuREPower, scan the below provided QR code and complete all the mandatory steps for successful installation and warranty registration.



For I&C Warranty registration links

Note: Filling out the form linked via the QR code is mandatory. Failure to provide installation details will result in the product's warranty being deemed null and void.

17. Display Setting

The LCD display information will be switched in turns by pressing "UP" or "DOWN" key. The selectable information is switched as below order: input voltage, input frequency, PV voltage, charging current, battery voltage, output voltage, output frequency, load in Watt, load in VA, load in Watt, DC discharging current, main board firmware version and SCC firmware version.

Select item	LCD display
Input voltage and output voltage (Default Display Screen)	<p>Input Voltage=230V, output voltage=230V</p>
Input frequency and output frequency	<p>Input frequency=50.0Hz, output frequency=50.0Hz</p>
Battery voltage and output voltage	<p>Battery Voltage=48.0V, output voltage=230V</p>
Battery voltage and load percentage	<p>Battery Voltage=48.0V, load percentage 68%</p>

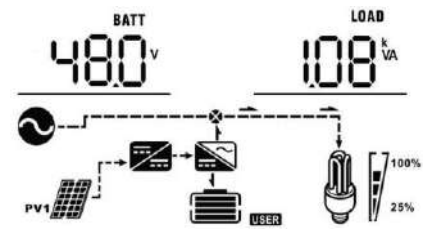
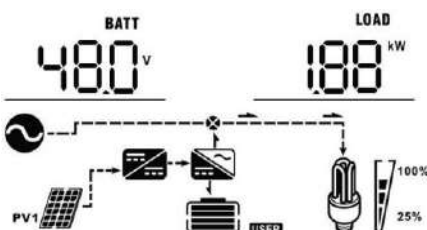
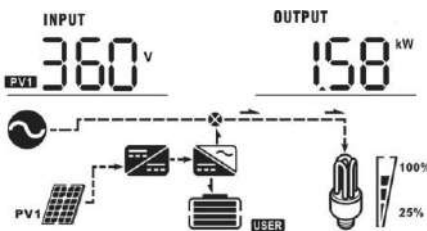
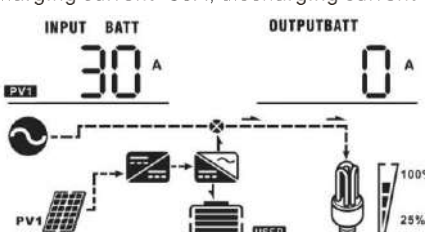
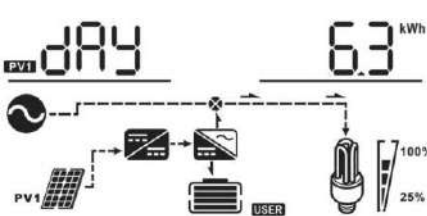

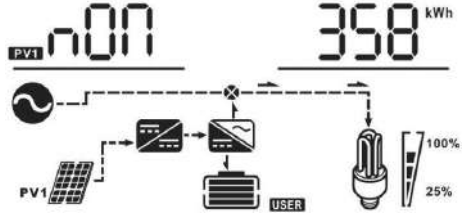
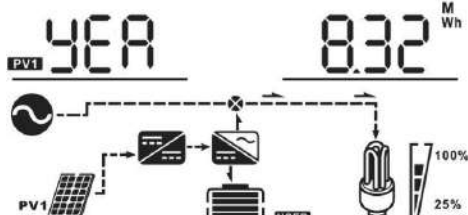
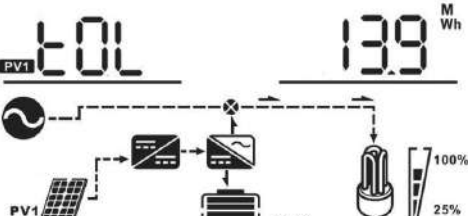
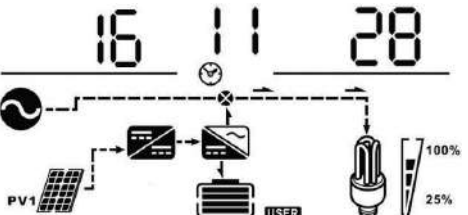
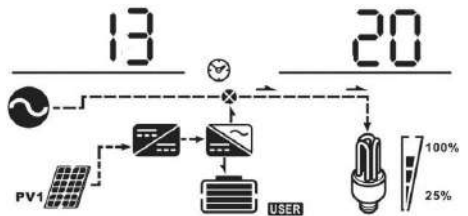
<p>Battery voltage and load in VA</p>	<p>Battery Voltage=48.0V, load in VA=1.08kVA</p> 
<p>Battery voltage and load in Watt</p>	<p>Battery Voltage=48.0V, load in Watt=1.88kW</p> 
<p>PV1 voltage and PV1 charger power</p>	<p>PV1 Voltage=360V, charging power=1.58kW</p> 
<p>Charger current and DC discharging current</p>	<p>Charging current=30A, discharging current=0A</p> 
<p>PV energy generated today</p>	<p>Today energy = 6.3kWh</p> 

<p>PV energy generated this month</p>	<p>This month energy = 358kWh.</p> 
<p>PV energy generated this year</p>	<p>This year energy = 8.32MWh</p> 
<p>PV energy generated totally</p>	<p>Total energy = 13.9MWh</p> 
<p>Real date</p>	<p>Real date Nov 28, 2016.</p> 
<p>Real time</p>	<p>Real time 13: 20.</p> 

Main board firmware version	Version 00001.00
-----------------------------	------------------

Operating Mode Description

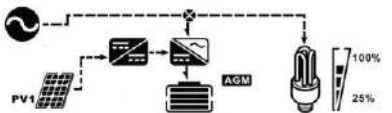
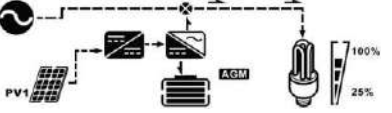
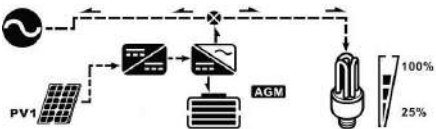
Operating mode	Behaviors	LCD display
Standby mode Note: *Standby mode: The inverter is not turned on yet but at this time, the inverter can charge battery without AC output. *Power swing mode: If enabled, the output of inverter will be off when connected load is pretty low or not detected.	No output power, solar or utility charger available	Battery is charged by utility.
		Battery is charged by PV energy.
		Battery is charged by utility and PV energy.
		Battery is charged by PV energy and feed PV energy grid.
		No charging.
Line mode	Output power from utility. Charger available	Utility charges battery and provides power to load.
		Utility and battery power provide power to load.

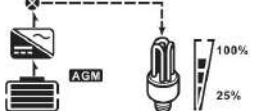
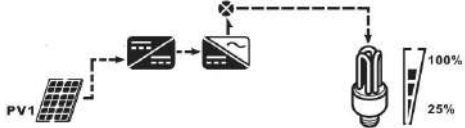
Line mode	Output power from utility. Charger available	<p>PV energy, battery power and utility provide power to load.</p> 
		<p>PV energy and utility charge battery, and utility provides power to load.</p> 
	Output power from utility. Charger available	<p>PV energy charges battery, utility and PV energy provide power to the load.</p> 
		<p>PV energy charges battery, PV energy provides power to the load and feeds remaining energy to the grid.</p> 
Battery mode		<p>PV energy charges battery, PV energy provides power to the load and feeds remaining energy to the grid.</p> 
	Output power from battery or PV	<p>PV energy and battery energy supply power to the load.</p> 
		<p>Battery provides power to the load.</p> 
Only PV mode	Output power from PV	<p>PV provides power to the load.</p> 



PuR Energy Limited

H. No 10-38/2, Survey no 424/AA3, Beside Arya College of Pharmacy Near IIT Hyderabad, Kandi
Village, Sangareddy, Pin Code: 502285
Customer Care: 1800 212 6440